

# TOSHIBA

## INSTRUCTION MANUAL

### CAMERA CONTROL UNIT

# IK-HD1C

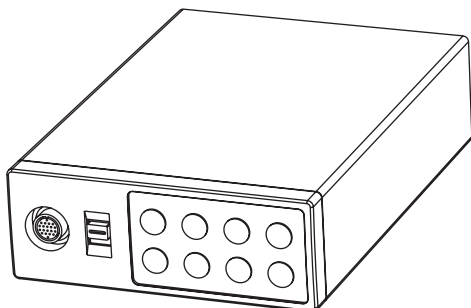

#### For Customer Use

Enter below the Serial # which is located on the bottom of the cabinet. Retain this information for future reference.

Model # IK-HD1C

Serial # \_\_\_\_\_

#### FCC NOTICE

This equipment has been tested and found to comply with the limits for a Class A digital device, pursuant to Part 15 of the FCC Rules. These limits are designed to provide reasonable protection against harmful interference when the equipment is operated in a commercial environment. This equipment generates, uses, and can radiate radio frequency energy and, if not installed and used in accordance with the instruction manual, may cause harmful interference to radio communications. Operation of this equipment in a residential area is likely to cause harmful interference in which case the user will be required to correct the interference at his own expense.

**USER-INSTALLER CAUTION:** Your authority to operate this FCC verified equipment could be voided if you make changes or modifications not expressly approved by the party responsible for compliance to Part 15 of the FCC Rules.

This Class A digital apparatus complies with Canadian ICES-003.

Cet appareil numérique de la classe A est conforme à la norme NMB-003 du Canada.

#### Following information is only for EU-member states:

The use of the symbol indicates that this product may not be treated as household waste. By ensuring this product is disposed of correctly, you will help prevent potential negative consequences for the environment and human health, which could otherwise be caused by inappropriate waste handling of this product. For more detailed information about the take-back and recycling of this product, please contact your supplier where you purchased the product or consult.



# SAFETY PRECAUTIONS

## Safety icons

This manual contains safety instructions that must be observed in order to avoid potential hazards that could result in personal injuries, damage to your equipment, or loss of data. These safety cautions have been classified according to the seriousness of the risk, and the icons highlight these instructions as follows:

---

**▲ WARNING** Indicates a potentially hazardous situation which, if not avoided, could result in death or serious injury.

---

---

**▲ CAUTION** Indicates a potentially hazardous situation which, if not avoided, may result in minor or moderate injury.

---

---

**CAUTION** Indicates a potentially hazardous situation which, if not avoided, may result in property damage.

---

---

**▲ WARNING** **Stop operation immediately if any abnormality or defect occurs.**  
Use during an abnormal condition; such as emitting smoke, burning odors, damage from dropping, invasion of foreign objects, etc. may result in fire and/or electrical shock. Immediately disconnect the power source and contact your dealer.

---

---

**▲ WARNING** **Avoid installing in a shower room or a bathroom.**  
This may result in fire and/or electrical shock.

---

---

**▲ WARNING** **Do not operate in places where the product may get wet.**  
This may result in fire and/or electrical shock.

---

---

**▲ WARNING** **Do not repair, disassemble and/or modify by yourself.**  
This may result in fire and/or electrical shock. Always be sure to contact your dealer for internal repair, check and cleaning of the product.

---

---

**▲ WARNING** **Use the specified power supply.**  
Otherwise, fire or electrical shock may occur.

---

---

**▲ WARNING** **Do not place anything on top of the unit.**  
Foreign materials, such as metals or liquids, getting into the product may result in fire and/or electrical shock.

---

---

**▲ WARNING** **Do not put the product on an unstable, slanted or vibrating surface.**  
The product dropping or falling may result in serious injury.

---

---

**▲ WARNING** **Do not touch the product or any connection cables during a thunderstorm.**  
This may result in electrical shock.

---

**CAUTION****Note the following instructions when installing.**

- Do not cover the product with any material.
  - Do not place the product on any inflammable material such as a carpet or blanket.
  - Do not place the product in a confined space, as this may cause heat to build up inside the product.
- Failure to follow the above cautions may result in fire.

**CAUTION****Do not place the product in direct sunshine and/or high temperature.**

Temperature build up inside the product may result in fire.

**CAUTION****Avoid placing in humid, smoky, or dusty places.**

This may result in fire and/or electrical shock.

**CAUTION****Ask your dealer to perform a periodical check and internal cleaning (approx. once every five years).**

Dust inside the product may result in fire. For check and cleaning cost, please consult your dealer.

The following description is for that a camera head “IK-HD1H” connected to this camera control unit.

**CAUTION****Do not point the lens directly at the sun and/or intensive light such as direct sunlight, etc.**

Focusing of the light may result in eye injury and/or fire.

## Disclaimer

We disclaim any responsibility and shall be held harmless for any damages or losses incurred by the user in any of the following cases:

1. Fire, earthquake or any other act of God; acts by third parties; misuse by the user, whether intentional or accidental; use under extreme operating conditions.
2. Malfunction or non-function resulting in indirect, additional or consequential damages, including but not limited to loss of expected income and suspension of business activities.
3. Incorrect use not in compliance with instructions in this instruction manual.
4. Malfunctions resulting from misconnection to other equipment.
5. Repairs or modifications made by the user or caused to be made by the user and carried out by an unauthorized third party.
6. Notwithstanding the foregoing, Toshiba’s liabilities shall not, in any circumstances, exceed the purchase price of the product.

## Copyright and Right of Portrait

There may be a conflict with the Copyright Law and other laws when a customer uses, displays, distributes, or exhibits an image picked up by the camera without permission from the copyright holder. Please also note that transfer of an image or file covered by copyright is restricted to use within the scope permitted by the Copyright Law.

## Protection of Personal Information

Images taken by the camera that reveal the likeness of an individual person may be considered personal information. To disclose, exhibit or transmit those images over the internet or otherwise, consent of the person may be required.

## Limitation of Usage

The product is not designed for any “critical applications.” “Critical applications” means life support systems, exhaust or smoke extraction applications, medical applications, commercial aviation, mass transit applications, military applications, homeland security applications, nuclear facilities or systems or any other applications where product failure could lead to injury to persons or less of life or catastrophic property damage. Accordingly, [Toshiba/TAIS] disclaims any and all liability arising out of the use of the product in any critical applications.

## TABLE OF CONTENTS

|   |    |
|---|----|
| 1. CAUTIONS ON USE AND INSTALLATION .....                                       | 6  |
| 2. COMPONENTS .....   | 6  |
| 3. ITEMS CONTROLLED BY THE ON SCREEN DISPLAY .....                              | 7  |
| 4. NAMES AND FUNCTIONS.....   | 8  |
| 5. CONNECTION.....  | 9  |
| 5.1 Standard Connection .....   | 9  |
| 5.2 Cautions on Connection.....   | 10 |
| 5.3 Connection on Back Panel.....   | 10 |
| 5.3A Connector Pin Assignments .....  | 10 |
| 6. OPERATION.....   | 11 |
| 6.1 Automatic Black Balance .....   | 11 |
| 6.2 White Balance.....  | 12 |
| 6.3 Scene File .....  | 14 |
| 6.4 Gain.....   | 14 |
| 6.5 Shading Correction .....  | 15 |
| 7. MODE SETTING BY THE ON SCREEN DISPLAY .....                                  | 16 |
| 7.1 Using the Menus .....   | 16 |
| 7.2 Menus .....   | 17 |
| (1) SHUTTER (Electronic shutter) .....  | 17 |
| (1.1) Changing the setting in AUTO mode.....                                    | 18 |
| (1.2) Changing the setting in MANUAL mode.....                                  | 20 |
| (1.3) Changing the setting in SS (Synchro. Scan) mode .....                     | 20 |
| (2) GAIN (Video gain) .....   | 21 |
| (2.1) Changing maximum gain in AUTO (Automatic gain control) mode .....         | 21 |
| (2.2) Changing gain in MANUAL mode.....   | 21 |
| (3) WHT BAL (White Balance).....  | 22 |
| (3.1) Changing the setting in AWB (Automatic White Balance) mode .....          | 22 |
| (3.2) Changing the setting in ATW (Automatic Tracking White balance) mode ..... | 23 |
| (3.3) Changing gain in MANUAL mode .....  | 24 |
| (4) PROCESS .....   | 25 |
| (4.1) Changing gamma correction ON/OFF .....                                    | 25 |
| (4.2) Changing gamma correction level.....                                      | 25 |
| (4.3) Changing detail (outline) gain .....                                      | 26 |
| (4.4) Changing master pedestal .....  | 26 |
| (4.5) Changing DNR(Digital Noise Reduction).....                                | 26 |
| (5) MATRIX(Matrix color correction) .....                                       | 27 |
| (5.1) Changing Matrix color correction ON/OFF .....                             | 27 |
| (5.2) Changing MATRIX setting .....   | 27 |

|   |           |
|---|-----------|
| (6) SYNC.....                                       | 28        |
| (6.1) INT screen.....                               | 28        |
| (6.2) Changing EXT. setting .....                   | 28        |
| (7) OPTION.....                                     | 29        |
| (7.1) Changing OUTPUT mode .....                    | 29        |
| (7.2) Changing shading correction mode .....        | 29        |
| (7.3) Changing manual shading correction mode ..... | 29        |
| (7.4) Changing RGB SYNC .....                       | 30        |
| (7.5) Changing RS232C baud rate .....               | 30        |
| (7.6) Changing OSD OUTPUT mode .....                | 30        |
| (8) Returning to factory settings .....             | 30        |
| 7.3 External Sync.....                              | 31        |
| (1) External sync signal input conditions.....      | 31        |
| (2) External sync frequency range .....             | 31        |
| (3) Using the unit with external sync signal.....   | 31        |
| (3.1) H (Horizontal) phase adjustment .....         | 31        |
| 7.4 Synchro. Scan Operation .....                   | 31        |
| (1) Setting by 1H .....                             | 31        |
| <b>8. BEFORE MAKING A SERVICE CALL.....</b>         | <b>32</b> |
| <b>9. SPECIFICATIONS .....</b>                      | <b>33</b> |
| <b>10. EXTERNAL APPEARANCE DIAGRAM.....</b>         | <b>34</b> |

# 1. CAUTIONS ON USE AND INSTALLATION

- **Handling the unit.**

Do not drop, jolt, or vibrate, as this may result in damage to the unit. This may cause problems. Treat the camera cables carefully to prevent cable problems, such as breaks in the cable and loose connections.

- **Install the camera in a location free from noise.**

If the camera or the cables are located near power utility lines or a TV, etc. undesirable noise may appear on the screen. In such a case, try to change the location of the camera or the cable wiring.

- **Operating ambient temperature and humidity.**

Do not use the camera in places where temperature and humidity exceed the specifications. Picture quality will deteriorate and internal parts may be damaged.

Be particularly careful when using in places exposed to direct sunlight. When shooting in hot places, depending on the conditions of the object and the camera (for example when the gain is increased), noise in the form of vertical strips or white dots may occur. This is not a malfunction.

- **When not using the camera for extended periods of time.**

Switch the control unit off and disconnect the power supply.

- **Avoid using or storing the camera in the following places:**

Places filled with highly flammable gas.

Places near gasoline, benzene, or paint thinner.

Places subject to strong vibration.

Places containing chemicals (such as pesticides), rubber or vinyl products for extended periods of time.

The following descriptions are for that a camera head "IK-HD1H" connected to this camera control unit.

- **Do not shoot intense light.**

If there is an intense light at a location on the screen such as a spot light, a blooming and smearing may occur. When intense light enters, vertical stripes may appear on the screen. This is not a malfunction. Ghosts may occur when there is an intense light near the object. In this case, change the shooting angle.

- **Moire**

A moire pattern is an interference pattern generated when two repetitive line patterns overlap. This is not a malfunction. Eliminating the repetitive line patterns, or aligning the two patterns, will eliminate the moire.

- **Handling of the camera head and protection cap.**

Keep the camera head and protection cap away from as they may pose a choking hazard. The protection cap protects the image sensing plane when the lens is removed from the camera head, do not discard.

- **When cleaning the camera.**

Unplug the power source before cleaning. Clean with a soft dry cloth only. Do not use chemicals or chemically treated cloths. Chemicals may damage coatings and printed letters. When cleaning the lens, use lens cleaning paper.

- **Installation without a tripod.**

Before installing the camera head, make sure that the location can withstand the total weight of the camera head.

If this is not the case, reinforce the area to prevent the unit from dropping, which may result in damage to the unit or personal injury.

# 2. COMPONENTS

|                               |   |
|-------------------------------|---|
| (1) Camera Control Unit ..... | 1 |
| (2) Accessories               |   |
| (a) Instruction manual .....  | 1 |

### 3. ITEMS CONTROLLED BY THE ON SCREEN DISPLAY

| Item                         |                     | Available selections  | Preset value<br>(Factory setting) |
|------------------------------|---------------------|---|-----------------------------------|
| Electronic shutter           | MODE                | AUTO, MANUAL, SS  | MANUAL                            |
|                              | AUTO level          | -100 – 0 – 100  | 0                                 |
|                              | AUTO peak/average   | 00 : 10 – 05 : 05 – 10 : 00   | 05 : 05                           |
|                              | AUTO response speed | 1 – 10 – 20   | 10                                |
|                              | AUTO area           | PRESET A, PRESET B, PRESET C,<br>PRESET D, PRESET E   | PRESET A                          |
|                              | MANUAL speed        | OFF, 1/100s, 1/125s, 1/250s, 1/500s, 1/1000s,<br>1/3000s, 1/5000s, 1/10000s, 1/30000s, 1/50000s | OFF                               |
|                              | Syncro. scan        | OFF, 1/1125H – 560/1125H  | OFF                               |
| Gain                         | AUTO maximum gain   | 0dB to 18dB   | 18dB                              |
|                              | MANUAL gain         | 0dB to 18dB   | 0dB                               |
| White balance                | Color temperature   | 3200K, 5600K  | 3200K                             |
|                              | AWB R PAINT         | -10 – 0 – 10  | 0                                 |
|                              | AWB B PAINT         | -10 – 0 – 10  | 0                                 |
|                              | AWB area            | PRESET A, PRESET B, PRESET C,<br>PRESET D, PRESET E   | PRESET A                          |
|                              | ATW R PAINT         | -10 – 0 – 10  | 0                                 |
|                              | ATW B PAINT         | -10 – 0 – 10  | 0                                 |
|                              | MANUAL R GAIN       | -100 – 0 – 100  | 0                                 |
|                              | MANUAL B GAIN       | -100 – 0 – 100  | 0                                 |
| Gamma correction             |                     | ON, OFF   | ON                                |
| Gamma correction level       |                     | -10 – 0 – 10  | 0                                 |
| Detail gain                  |                     | -7(OFF) – 0 – 7   | 0                                 |
| Master pedestal              |                     | -100 – 0 – 100  | 0                                 |
| Digital noise reduction(DNR) |                     | ON, OFF   | OFF                               |
| Matrix color correction      | Correction ON/OFF   | ON, OFF   | ON                                |
|                              | R hue               | -15 – 0 – 15  | 0                                 |
|                              | R gain              | -15 – 0 – 15  | 0                                 |
|                              | G hue               | -15 – 0 – 15  | 0                                 |
|                              | G gain              | -15 – 0 – 15  | 0                                 |
|                              | B hue               | -15 – 0 – 15  | 0                                 |
|                              | B gain              | -15 – 0 – 15  | 0                                 |
|                              | Ye hue              | -15 – 0 – 15  | 0                                 |
|                              | Ye gain             | -15 – 0 – 15  | 0                                 |
|                              | Cy hue              | -15 – 0 – 15  | 0                                 |
|                              | Cy gain             | -15 – 0 – 15  | 0                                 |
|                              | Mg hue              | -15 – 0 – 15  | 0                                 |
| Mg gain                      | -15 – 0 – 15        | 0   |                                   |
| Ext. Sync                    | H phase adjustment  | -1024 – 0 – 1023  | 0                                 |
| OUTPUT                       |                     | Y/P <sub>b</sub> /P <sub>r</sub> , RGB  | Y/P <sub>b</sub> /P <sub>r</sub>  |
| Shading correction mode      |                     | SET, MANUAL, OFF  | OFF                               |
| Manual shading correction    |                     | -128 – 0 – 127  | 0                                 |
| RGB SYNC                     |                     | G, ALL ON, ALL OFF  | G                                 |
| RS232C baud rate             |                     | 9600bps, 19200bps   | 9600bps                           |
| OSD OUTPUT                   |                     | ALL ON, Analog, Digital   | ALL ON                            |

## 4. NAMES AND FUNCTIONS

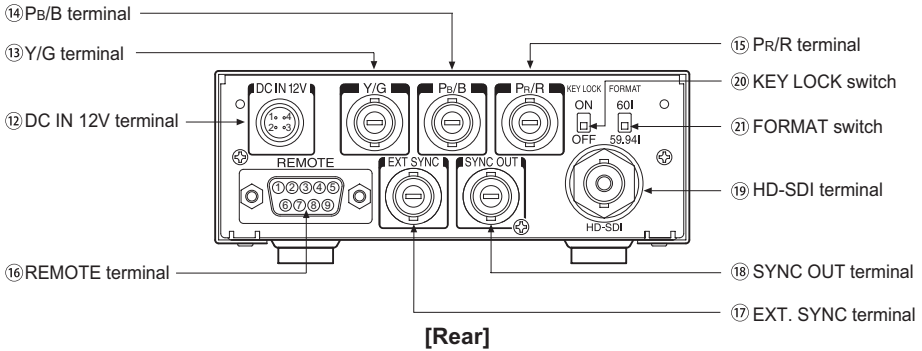
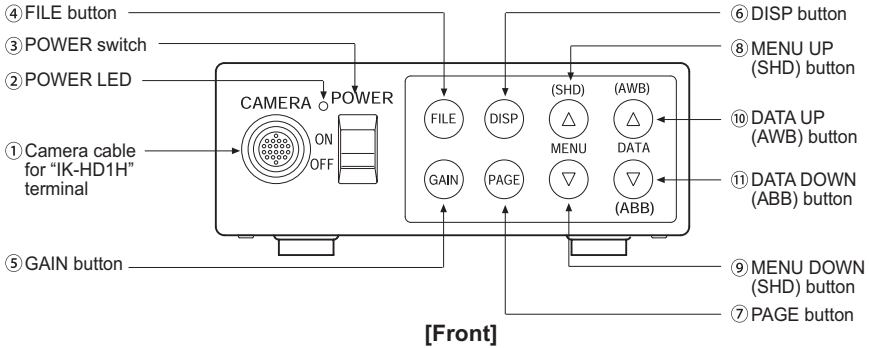

- |                                       |  |
|---------------------------------------|--|
| ① Camera cable for "IK-HD1H" terminal | Where the camera cable for "IK-HD1H" is connected.   |
| ② POWER LED                           | Illuminates to indicate the unit is powered on.  |
| ③ POWER switch                        | Turns power on or off.   |
| ④ FILE button                         | To switch the scene files.   |
| ⑤ GAIN button                         | To change the gain mode.   |
| ⑥ DISP button                         | Changes the display mode.  |
| ⑦ PAGE button                         | To switch and select menus.  |
| ⑧ MENU UP(SHD) button                 | To select the function to be confirmed or changed on the menu.<br>(Also used when performing auto shading correction.) |
| ⑨ MENU DOWN(SHD) button               | To select and confirm the function or to change the menu.  |
| ⑩ DATA UP(AWB) button                 | To change the value of the function selected by the MENU (UP/DOWN) button.<br>(Also used when using AWB.)              |
| ⑪ DATA DOWN (ABB) button              | To change the value of the function selected by the MENU (UP/DOWN) button.<br>(Also used when using ABB.)              |

- ⑫ DC IN 12V terminal                    Accept a DC power input (12V).
- ⑬ Y/G terminal                            Outputs Y or G. (BNC connector)
- ⑭ P<sub>B</sub>/B terminal                        Outputs P<sub>B</sub> or B. (BNC connector)
- ⑮ P<sub>R</sub>/R terminal                        Outputs P<sub>R</sub> or R. (BNC connector)
- ⑯ REMOTE terminal                      To connect to a RS-232C device for remote control function.
- ⑰ EXT. SYNC terminal                  Used when the camera output signal is synchronized to an external signal. (BNC connector)
- ⑱ SYNC OUT terminal                  Output terminal for synchronization signal. (BNC connector)
- ⑲ HD-SDI terminal                      Video signal output terminal for HD-SDI format video signal. (BNC connector)
- ⑳ KEY LOCK switch                    Enables/disables buttons ④ to ⑩.
- ㉑ FORMAT switch                      Switches between 59.94i and 60i.

## 5. CONNECTION

### 5. 1 Standard Connection

#### 5. 1 -1 Analog Connection

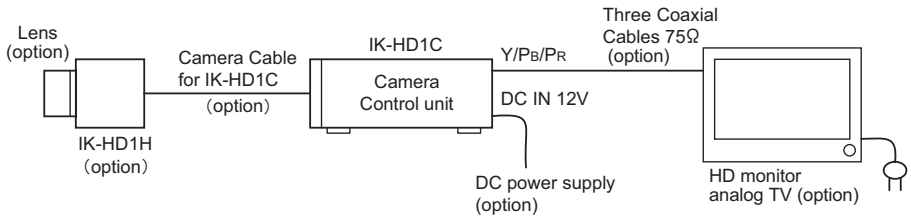

#### 5. 1 -2 Digital Connection

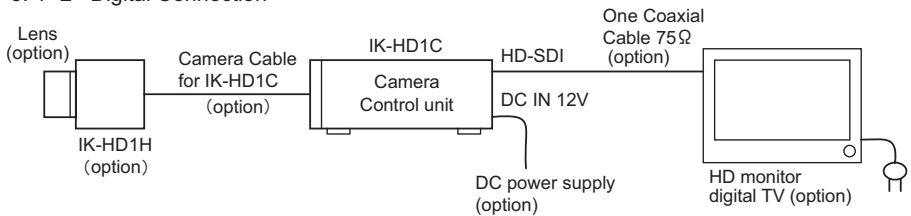

\* Please use a low conductor resistance cable for HD-SDI terminal.

## 5. 2 Caution on Connection

- Only use optional camera head model # IK-HD1H with this camera controller. The use of another head may cause damage to the control unit and camera head.
- When connecting the camera cables, be sure to turn off the camera control unit and any other equipment connected to it.
- For DC power supply connecting to DC IN 12V terminal, use UL listed and/or CSA approved ungrounded type AC adaptor with the specifications described below.

Power supply voltage : 12V DC  $\pm$  10%

Current rating : More than 830mA, Less than 2.5A

Ripple voltage : Less than 50mV (p-p)

Connector : HR10A-7P-4S by HIROSE electronics Co. Ltd

Pins 1, 2 : 12V

Pins 3, 4 : GND

- If the securing screw on the connector of the camera cable loosens, noise may appear on the screen. Be sure to tighten the connector completely.

## 5. 3 Connection on Back Panel

### Back panel view

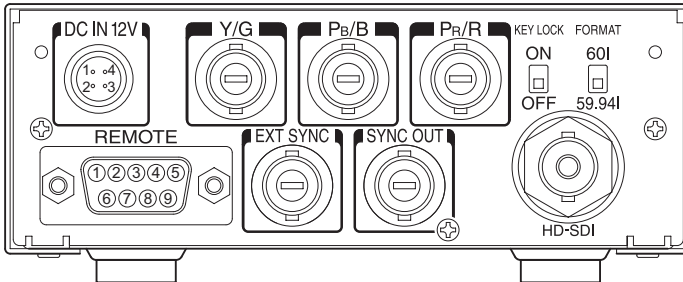

## 5. 3A Connector Pin Assignments

### DC IN 12V

|   |      |
|---|------|
| 1 | +12V |
| 2 | +12V |
| 3 | GND  |
| 4 | GND  |

### REMOTE

|   |     |
|---|-----|
| 1 | NC  |
| 2 | TXD |
| 3 | RXD |
| 4 | NC  |
| 5 | GND |
| 6 | NC  |
| 7 | NC  |
| 8 | NC  |
| 9 | NC  |

## 6. OPERATION

A camera head "IK-HD1H" needs to be connected to this camera control unit from this section on.

- ① Refer to the item "5. CONNECTION", connect the equipment correctly.
- ② Turn on the connected equipment and the camera.
- ③ When using the camera for the first time and when replacing the camera cable and the camera head, be sure to perform the ABB adjustment, refer to the item "6.1 Automatic Black Balance".
- ④ Aim the lens at the object, adjust the lens iris adjustment, focus adjustment, etc.
- ⑤ Refer to the item "6.2 White Balance", make the adjustment.
- ⑥ Refer to the items "6.3 Scene File, 6.4 Gain, 7. MODE SETTING BY THE ON SCREEN DISPLAY", select the necessary items.

### 6. 1 Automatic Black Balance

Black balance adjustment is necessary to get the correct black picture level.

- Close the lens iris.
- If the color bar pattern is displayed on the screen or if the index menu/menu is displayed, press the [DISP] button to disable the color bar pattern or the character display.
- Hold the [DATA DOWN] button for approx. 1 second.
- When the black balance adjustment operation starts, the character ABB blinks on the screen.
- When the black balance adjustment operation finishes, the character ABB stops blinking and the result appears for approx. 1 second.

| Display              | Meaning  |
|----------------------|--|
| ABB OK               | Automatic black balance adjustment finished correctly.   |
| ABB NG<br>CLOSE LENS | Automatic black balance adjustment cannot be performed because the lens iris is open. Close the lens iris. |
| ABB NG               | Automatic black balance adjustment cannot be performed.<br>Operate the automatic black balance again.      |

## 6. 2 White Balance

For white balance adjustment of this unit, ATW (Automatic Tracking White balance), AWB (Automatic White Balance) and MANUAL (Manual white balance) adjustments are provided. Refer to the items “7.2 (3) WHT BAL (White Balance), 7. MODE SETTING BY THE ON SCREEN DISPLAY”, select the desired mode.

|                 | <b>ATW<br/>(Automatic Tracking<br/>White Balance)</b>   | <b>AWB<br/>(Automatic White Balance)</b>  | <b>MANUAL<br/>(Manual White Balance)</b>   |
|-----------------|---|---|--|
| <b>Outline</b>  | The camera measures the object color temperature and adjusts the white balance automatically. | Adjust white balance by displaying the white object inside the area set by AWB menu and pressing the [DATA UP] button.    | Adjust the white balance manually using the WHT BAL menu while shooting the white object.  |
| <b>Features</b> | Tracks variations of color temperature and adjusts white balance automatically.               | Measurement accuracy is higher than ATW. This mode is effective when shooting under less variations of color temperature. | Artificial white balance setting. The manual adjustment is most effective under shooting conditions with no color temperature variation. |
| <b>Notes</b>    | If illumination is low, white balance may not be corrected.                                   |   | Adjustment is performed by confirming with a vector scope.   |

### ① AWB(Automatic White Balance)

- Set the MODE to AWB on the WHT BAL menu.

Perform the C.TEMP (color temperature conversion) setting, if necessary.

(Refer to the item “7.2 (3) WHT BAL (White Balance)”.)

3200K: Appropriate for indoor shooting.

5600K: Appropriate for outdoor shooting.

- If the color bar pattern is displayed on the screen or if the index menu/menu is displayed, press the [DISP] button to disable the color bar pattern or the character display on the menu.
- Shoot a known white object entirely in the area set by the AWB menu (refer to the item “7.2 (3) (3.1) (d) Confirming the contents of the zone area selected by AWB” ) and push [DATA UP] button for approx. 1 second.
- The character AWB blinks on the screen when the AWB starts.
- The character AWB stops blinking when the AWB finishes, and the result is displayed for approx. 1 second.

| Display                        | Meaning   |
|--------------------------------|---|
| <b>AWB OK</b>                  | Automatic white balance adjustment finished correctly.  |
| <b>AWB NG<br/>LEVEL LOW</b>    | Automatic white balance adjustment cannot be performed because the video level is too low.<br>Adjust the video level by increasing the illumination or opening the lens iris.   |
| <b>AWB NG<br/>LEVEL HIGH</b>   | Automatic white balance adjustment cannot be performed because the video level is too high.<br>Adjust the video level by decreasing the illumination or closing the lens iris.  |
| <b>AWB NG<br/>C. TEMP LOW</b>  | Automatic white balance adjustment cannot be performed because the color temperature is too low.<br>If the C.TEMP is set to 5600K, set to 3200K.<br>If the message appears with the C.TEMP set to 3200K, change the illumination or use a color temperature conversion filter.    |
| <b>AWB NG<br/>C. TEMP HIGH</b> | Automatic white balance adjustment cannot be performed because the color temperature is too high.<br>If the C.TEMP is set to 3200K, set to 5600K.<br>If the message appears with the C.TEMP set to 5600K, change the illumination or use the color temperature conversion filter. |
| <b>AWB NG</b>                  | Automatic white balance adjustment cannot be performed for other reasons. Such as no white area is included in an object, etc.  |

② MANUAL(Manual white balance)

- Set the MODE to MANUAL on the WHT BAL menu.  
(Refer to the item "7.2 (3) WHT BAL (White Balance)".)
- Shoot a known white object, set the white balance by adjusting the levels of R GAIN and B GAIN on the menu, confirming with a monitor or a vector scope.  
(Refer to the item "7.2 (3) (3.3) Changing gain in MANUAL mode".)

### 6. 3 Scene File

Five scene files (A, B, C, D, E) are available as user memories for this unit. These are chosen depending on shooting conditions. By using the [FILE] button, the camera operation is changed immediately from the currently selected Scene File to the next. (Refer to the item “7. MODE SETTING BY THE ON SCREEN DISPLAY”.)

- While any menu is displayed, pressing the [FILE] button will display the menu settings for the next Scene File:



- When the [FILE] button is pressed while the camera is in live image mode, the current scene file selection at that time is displayed for approx. 3 seconds in the upper right corner of the screen. If the [FILE] button is pressed again while the position is displayed, the scene file cycles as described above.

### 6. 4 Gain

When the image is dark even if the lens iris is open, change the gain (video gain) to get the desired video level. For gain adjustment of the unit, AUTO (Automatic gain control), MANUAL (Manual), OFF (0 dB) modes are provided. Select the mode on the GAIN menu. (Refer to the item “7.2 (2) GAIN (Video gain)”.)

#### ① AUTO(Automatic gain control)

When the output is low, gain is automatically adjusted to a suitable video level.

The maximum value of gain is 18dB, and can be set from 0 to 18dB in 1dB steps. (Refer to the item “7.2 (2) (2.1) Changing the maximum gain in AUTO (Automatic gain control) mode”.)

Video level (LEVEL), peak average value ratio (PEAK/AVE), and measurement light area (AREA) is linked to the setting on the automatic shutter. (Refer to the item “7.2 (1) (1.1) Changing the setting in AUTO mode”.)

#### ② MANUAL(Manual gain)

Gain adjustment is performed on the GAIN menu. The adjustment range is from 0 to 18dB in 1dB steps. (Refer to the item “7.2 (2) (2.2) Changing gain in MANUAL mode”.)

#### ③ OFF

Gain is fixed at 0 dB.

Gain button

- ① If the [GAIN] button is pressed, the current setting mode is on the GAIN menu for approx. 3 seconds.

GAIN menu : OFF → GAIN OFF  
              : AUTO → GAIN AUTO  
              : MANUAL \* \* dB → GAIN dB

※ “\* \*” shows the setting gain in MANUAL mode.

- ② If the [GAIN] button is pressed again while the current setting mode is displayed, the gain mode can be changed.

GAIN of MAX GAIN in AUTO mode and MANUAL mode can not be changed.



**Note:**

**White, red, green, or blue dots may occur when the gain is increased. This is not a malfunction, just certain characteristics of the CCD becoming more visible.**

**6. 5 Shading Correction**

Due to the lens used or the environmental condition, color shading may occur at the upper and lower edge of the screen. If this happens, the shading correction function can be used to decrease the amount of color shading. For shading correction of the unit, SET (Automatic shading correction), MANUAL (Manual shading correction), and OFF (no shading correction) modes are provided. Select the mode on the OPTION menu. (Refer to the item “7.2 (7) (7.2) Changing shading correction mode”.)

① SET(Auto shading)

- If the color bar pattern is displayed on the screen or if the index menu/menu is displayed, press the [DISP] button to remove them from the screen.
- Push the [MENU UP] button for approx. 1 second.
- When the automatic shading correction operation starts, the character SHD blinks on the screen.
- When the automatic shading correction operation terminates, the character SHD ends blinking and the result is displayed for approx. 1 second.

| Display                      | Meaning   |
|------------------------------|---|
| <b>SHD OK</b>                | Automatic shading correction operation finished correctly.  |
| <b>SHD OK<br/>LIMIT</b>      | Automatic shading correction operation finished, however, the correction necessary exceeds the camera's range so the maximum possible value is applied.               |
| <b>SHD NG<br/>LEVEL LOW</b>  | Automatic shading correction cannot be performed because the video level is too low. Adjust the video level by increasing the illumination or opening the lens iris.  |
| <b>SHD NG<br/>LEVEL HIGH</b> | Automatic shading correction cannot be performed because the video level is too high. Adjust the video level by decreasing the illumination or closing the lens iris. |

② MANUAL(Manual Shading)

Perform the correction amount setting on the OPTION menu, confirming with a monitor or a vector scope. (Refer to the “7.2 (7) (7.3) Changing manual shading correction mode”.)

③ OFF

The status is no shading correction.

**\* Shading correction is only effective when the lens iris and zoom ratio is fixed. Use the unit with SHADING OFF for variable lens conditions.**

**Note:**

**Before shading correction is performed, please shoot a known white object that fills the screen in the proper video level and set the automatic white balance (AWB) .**

## 7. MODE SETTING BY THE ON SCREEN DISPLAY

Various settings can be controlled on the unit by using the on screen menu displayed on the monitor. The contents once set are memorized in the scene files (A, B, C, D, E) selected, so if the power turns off, it is unnecessary to set again when using the unit next time. When the setting is performed, select the menu of the item to be set.

### 7. 1 Using the Menus

When the power turns on, the normal screen showing only the video signal appears. Change the output to each screen (video signal output, color bar screen, Index menu, menus, and area menu) by using the [DISP], [PAGE], [MENU UP], and [MENU DOWN] buttons.

\* A menu is selected when pushing the [PAGE] button after moving the "→" on the screen by the [MENU UP], [MENU DOWN] button while the Index menu is displayed.

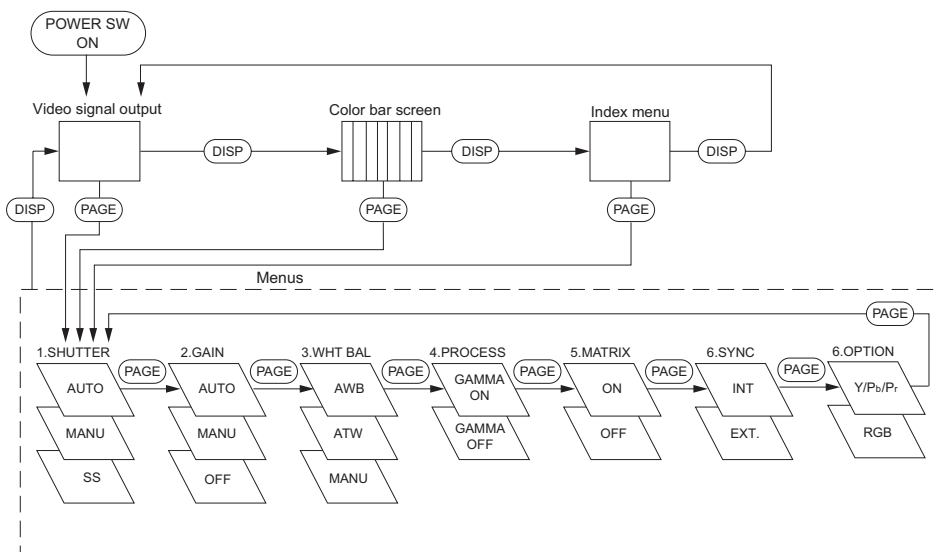

## 7. 2 Menus

- Select the menu to change the setting by referring to the item "7.1 Using the Menus".
- When the [MENU UP], [MENU DOWN] buttons are pushed, the "→" on the screen moves up and down. Move the "→" to the item whose setting you wish to change.

### (1) SHUTTER (Electronic shutter)

The electronic shutter has four modes; AUTO, MANUAL, SS(Synchro. Scan).

Press the "Page" button to enter the Shutter Page. Use the "Data Up/Down" buttons to select the Shutter Mode.



AUTO : The exposure time is controlled automatically to obtain the video level set.

MANUAL : It is possible to select the exposure time from eleven speed settings; OFF (1/60s), 1/100s, 1/125s, 1/250s, 1/500s, 1/1000s, 1/3000s, 1/5000s, 1/10000s, 1/30000s, 1/50000s.

**Note:**

**When setting a rapid shutter speed, sensitivity degrades according to the speed.  
When a discharging light such as fluorescent lamp, etc. is used for the illumination, the flicker may be large.**

SS : Shutter speed can be set by the horizontal scanning time (1H) unit.

## (1. 1) Changing the setting in AUTO mode

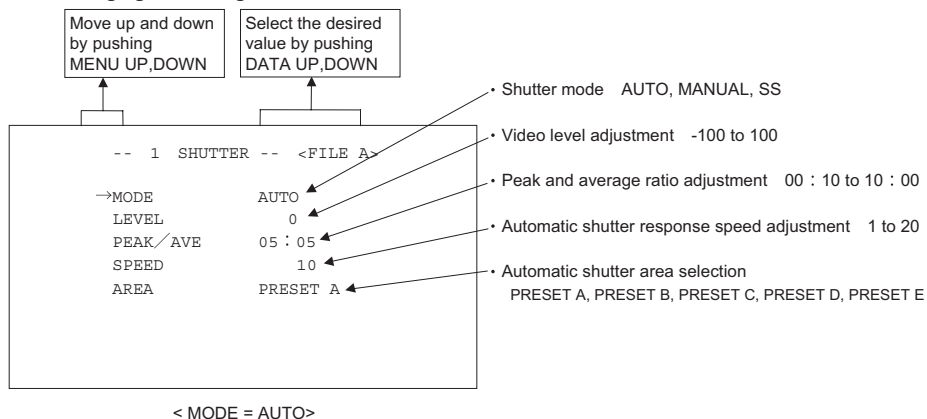

### (a) Changing the video level in the automatic shutter mode

- ① Move the "→" to LEVEL by pushing [MENU UP], [MENU DOWN] buttons.
- ② Select the video level by pushing [DATA UP], [DATA DOWN] buttons.

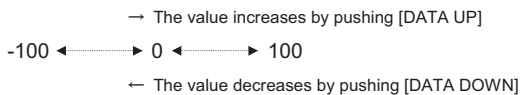

### (b) Changing the automatic shutter detection (ratio between peak and average value)

- ① Move the "→" to PEAK/AVE by pushing [MENU UP], [MENU DOWN] buttons.
- ② Select the ratio between peak and average value by pushing [DATA UP], [DATA DOWN] buttons.

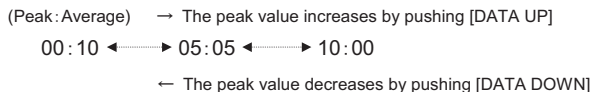

### (c) Changing the automatic shutter response speed

- ① Move the "→" to SPEED by pushing [MENU UP], [MENU DOWN] buttons.
- ② Select the response speed by pushing [DATA UP], [DATA DOWN] buttons.

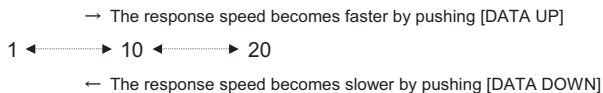

**(d) Changing the automatic shutter zone area**

- ① Move the “→” to AREA by pushing [MENU UP], [MENU DOWN] buttons.
- ② Select the measurement light area by pushing [DATA UP], [DATA DOWN] buttons.



The available picture area is shown by the shading correction on the screen that is parted in 64.



PRESET A

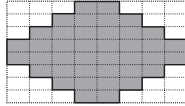

PRESET B

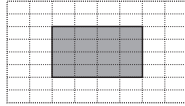

PRESET C

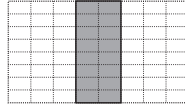

PRESET D



PRESET E

## (1. 2) Changing the setting in MANUAL mode

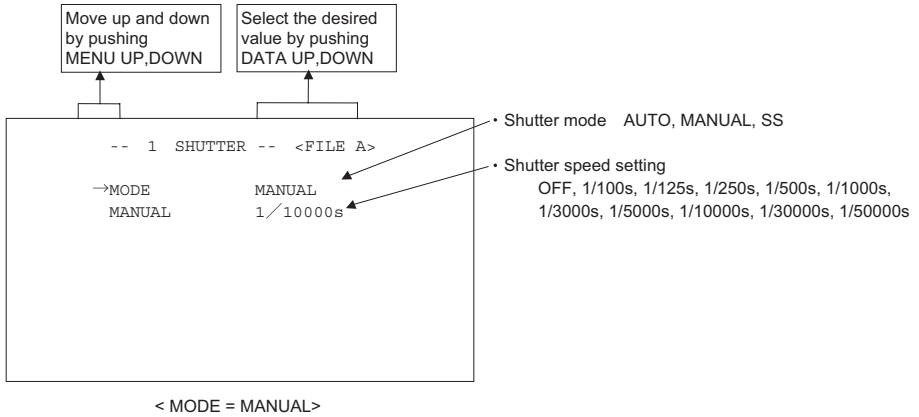

### (a) Changing the shutter speed

- ① Move the "→" to MANU by pushing [MENU UP], [MENU DOWN] buttons.
- ② Select the shutter speed by pushing [DATA UP], [DATA DOWN] buttons.

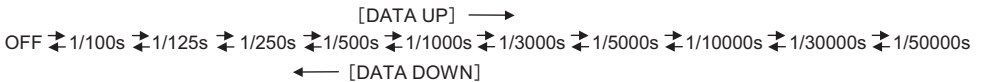

## (1. 3) Changing the setting in SS (Synchro. Scan) mode

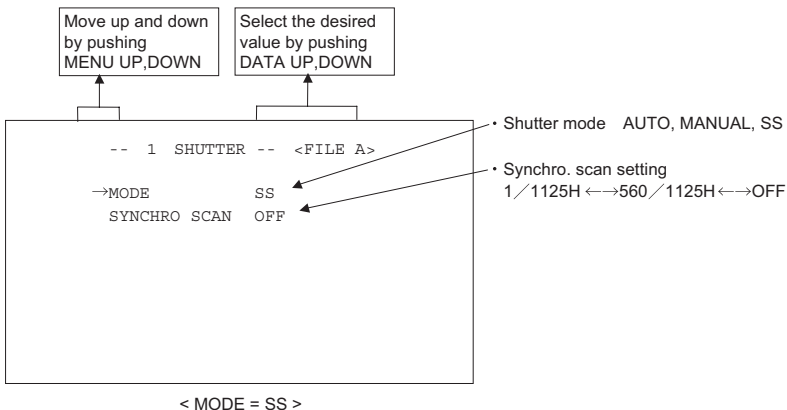

### (a) Changing the shutter speed setting

- ① Move the "→" to SYNCHRO SCAN by pushing [MENU UP], [MENU DOWN] buttons.
- ② Select the shutter speed by pushing [DATA UP], [DATA DOWN] buttons.



## (2) GAIN (Video gain)

GAIN has three modes; AUTO, MANUAL, OFF.

Move the "→" to MODE, push the [DATA UP], [DATA DOWN], and select one of the three modes :  
AUTO, MANUAL, OFF. In the OFF mode, gain is fixed to 0dB.

### (2. 1) Changing maximum gain in AUTO (Automatic gain control) mode

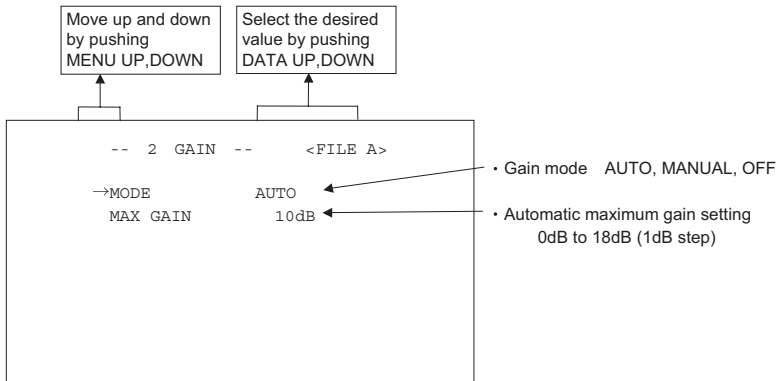

- ① Move the "→" to MAX GAIN by pushing [MENU UP], [MENU DOWN] buttons.
- ② Select the desired value of automatic maximum gain by pushing [DATA UP], [DATA DOWN] buttons.

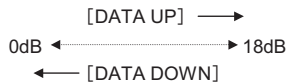

### (2. 2) Changing gain in MANUAL mode

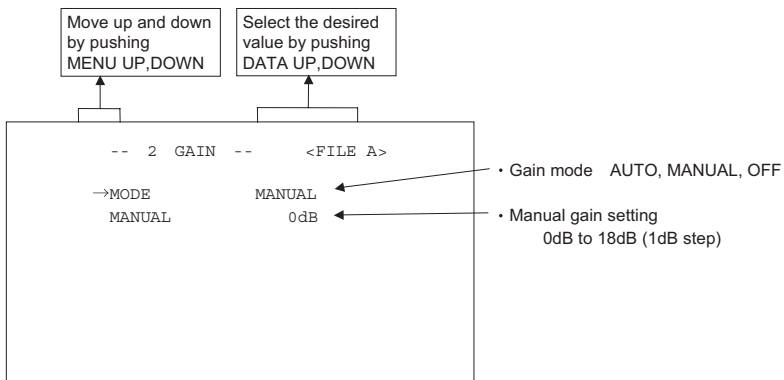

- ① Move the "→" to MANUAL by pushing [MENU UP], [MENU DOWN] buttons.
- ② Select the desired value of manual gain by pushing [DATA UP], [DATA DOWN] buttons.

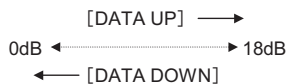

### (3) WHT BAL(White Balance)

The WHT BAL has three modes; AWB, ATW, MANUAL.

Move the "→" to MODE, push the [DATA UP], [DATA DOWN], and select one of the three modes : AWB, ATW, MANUAL.

#### (3. 1) Changing the setting in AWB(Automatic White Balance) mode

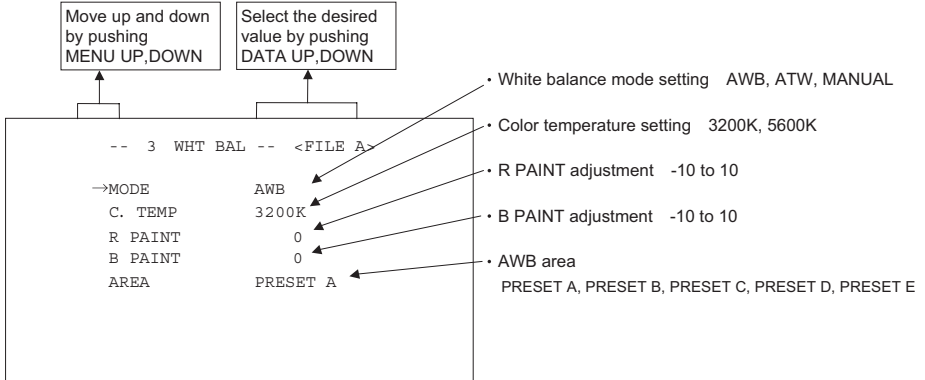

#### (a) Changing color temperature setting

- ① Move the "→" to C.TEMP by pushing [MENU UP], [MENU DOWN] buttons.
- ② Select either 3200K or 5600K by pushing [DATA UP], [DATA DOWN] buttons.

#### (b) Changing R PAINT

- ① Move the "→" to R PAINT by pushing [MENU UP], [MENU DOWN] buttons.
- ② Select the desired value of red paint by pushing [DATA UP], [DATA DOWN] buttons.

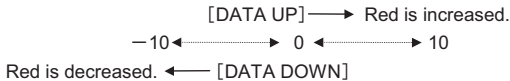

#### (c) Changing B PAINT

- ① Move the "→" to B PAINT by pushing [MENU UP], [MENU DOWN] buttons.
- ② Select the desired value of blue paint by pushing [DATA UP], [DATA DOWN] buttons.

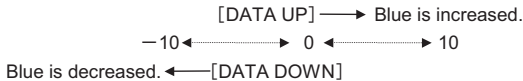

#### (d) Confirming the contents of the zone area selected by AWB

- ① Move the "→" to AREA DISP by pushing [MENU UP], [MENU DOWN] buttons.
- ② Select the desired area by pushing [DATA UP], [DATA DOWN] buttons.

The available picture area is shown by the shading correction on the screen that is parted in 64.

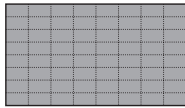

PRESET A

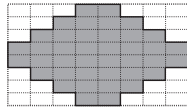

PRESET B

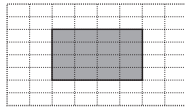

PRESET C

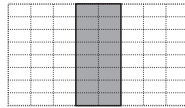

PRESET D



PRESET E

### (3. 2) Changing the setting in ATW(Automatic Tracking White balance) mode

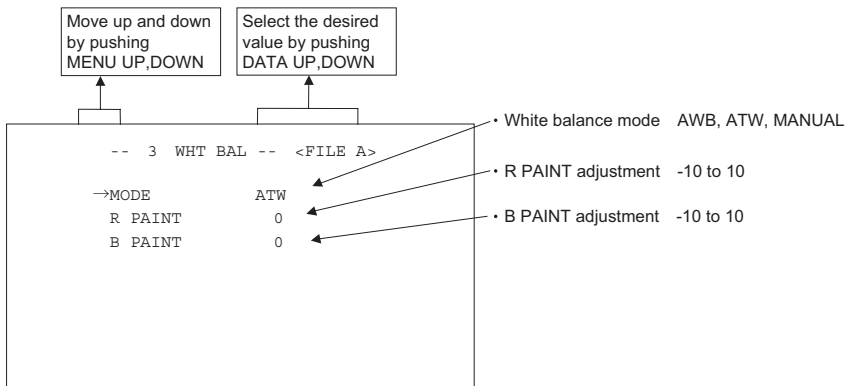

#### (a) Changing R PAINT

- Move the "→" to R PAINT by pushing [MENU UP], [MENU DOWN] buttons.
- Select the desired value of red paint by pushing [DATA UP], [DATA DOWN] buttons.

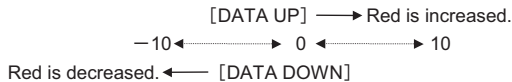

#### (b) Changing B PAINT

- Move the "→" to B PAINT by pushing [MENU UP], [MENU DOWN] buttons.
- Select the desired value of blue paint by pushing [DATA UP], [DATA DOWN] buttons.

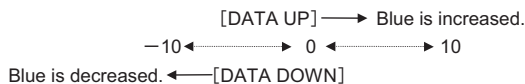

### (3. 3) Changing gain in MANUAL mode

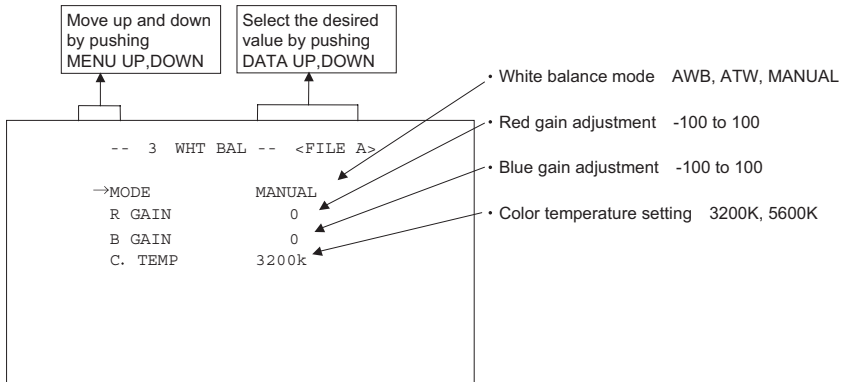

#### (1) Changing the red gain

- ① Move the "→" to R GAIN by pushing [MENU UP], [MENU DOWN] buttons.
- ② Select the desired value of red gain by pushing [DATA UP], [DATA DOWN] buttons.

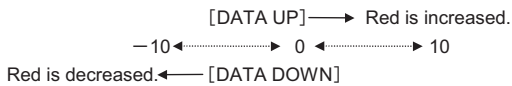

#### (2) Changing the blue gain

- ① Move the "→" to B GAIN by pushing [MENU UP], [MENU DOWN] buttons.
- ② Select the desired value of blue gain by pushing [DATA UP], [DATA DOWN] buttons.

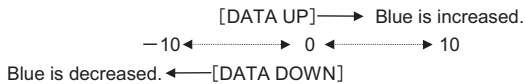

#### (4) PROCESS

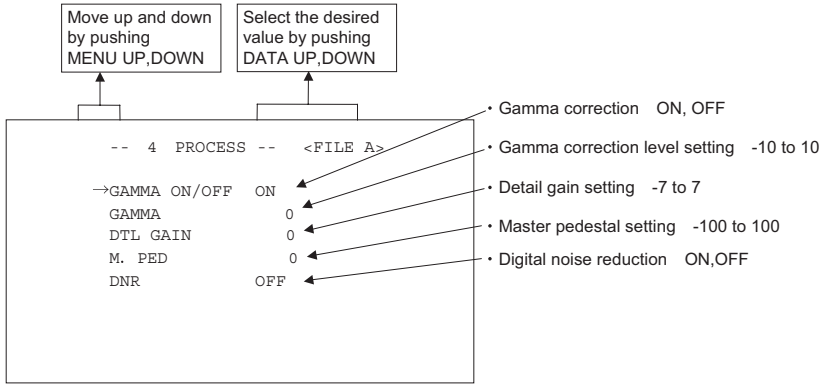

##### (4. 1) Changing gamma correction ON/OFF

- ① Move the "→" to GAMMA ON/OFF by pushing [MENU UP], [MENU DOWN] buttons.
- ② Select either ON or OFF by pushing [DATA UP], [DATA DOWN] buttons.

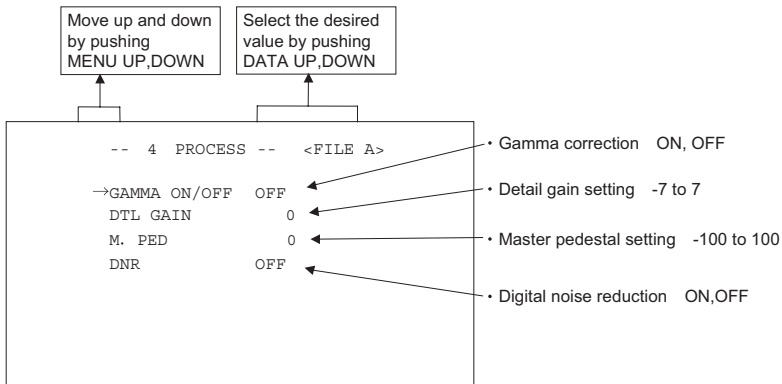

Menu when GAMMA OFF is selected.

##### (4. 2) Changing gamma correction level

- ① Move the "→" to GAMMA by pushing [MENU UP], [MENU DOWN] buttons.
- ② Select the desired value of gamma correction level by pushing [DATA UP], [DATA DOWN] buttons.



\* When OFF is selected in GAMMA ON/OFF selection line, the gamma correction level change cannot be changed.

#### (4. 3) Changing detail (outline) gain

- ① Move the “→” to DTL GAIN by pushing [MENU UP], [MENU DOWN] buttons.
- ② Select the desired value of the detail gain by pushing [DATA UP], [DATA DOWN] buttons.

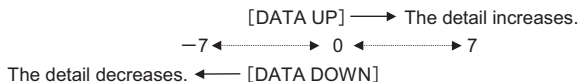

#### (4. 4) Changing master pedestal

- ① Move the “→” to M. PED by pushing [MENU UP], [MENU DOWN] buttons.
- ② Select the desired value of the master pedestal by pushing [DATA UP], [DATA DOWN] buttons.

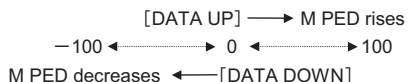

#### (4. 5) Changing DNR (Digital Noise Reduction)

- ① Move the “→” to DNR by pushing [MENU UP], [MENU DOWN] buttons.
- ② Select either ON or OFF by pushing [DATA UP], [DATA DOWN] buttons.

#### Note:

When DNR is set to ON, noise is reduced, an accidental image might be outstanding while shooting moving objects.

**(5) MATRIX(Matrix color correction)**

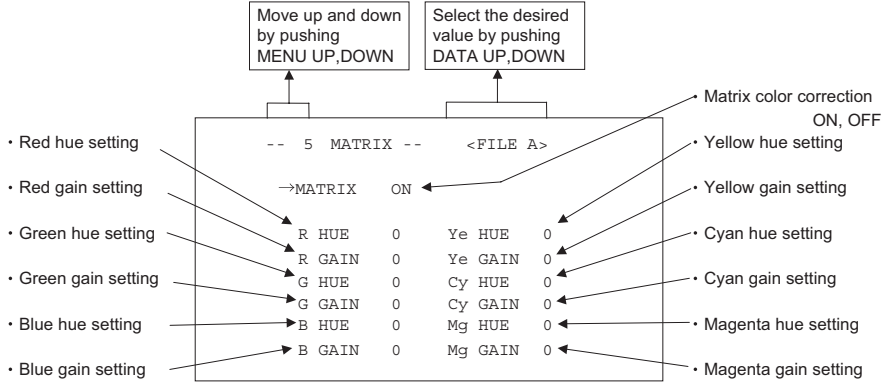

**(5. 1) Changing Matrix color correction ON/OFF**

- ① Move the “→” to MATRIX by pushing [MENU UP], [MENU DOWN] buttons.
- ② Select either ON or OFF by pushing [DATA UP], [DATA DOWN] buttons.

**(5. 2) Changing MATRIX setting**

- ① Move the “→” to the desired item by pushing [MENU UP], [MENU DOWN] buttons.
- ② Select the desired value of color by pushing [DATA UP], [DATA DOWN] buttons.



**\* When matrix color correction is set to OFF, the color cannot be adjusted.**

## (6) SYNC

When an external sync signal is input, the display changes from INT (internal sync) to EXT.(external sync) automatically.

INT ← → EXT

### (6. 1) INT screen

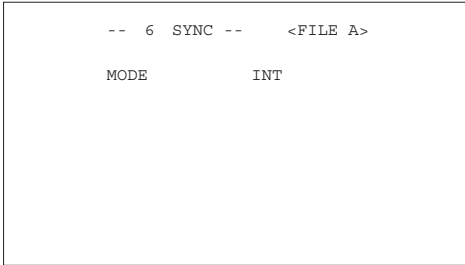

### (6. 2) Changing EXT. setting

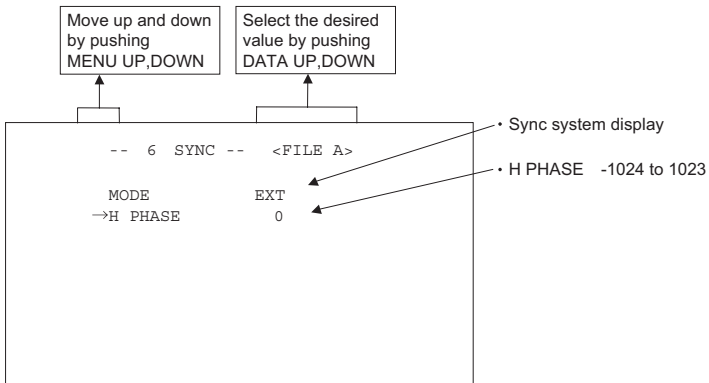

#### (a) Adjusting horizontal phase

- ① Move the "→" to H PHASE by pushing [MENU UP], [MENU DOWN] buttons.
- ② Select the desired value of horizontal phase by pushing [DATA UP], [DATA DOWN] buttons.

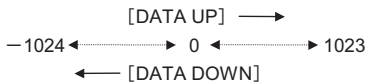

\* If the phase difference is big, press [DATA UP]/[DATA DOWN] button for a while.  
It makes the setting shift by tens place.

**(7) OPTION**

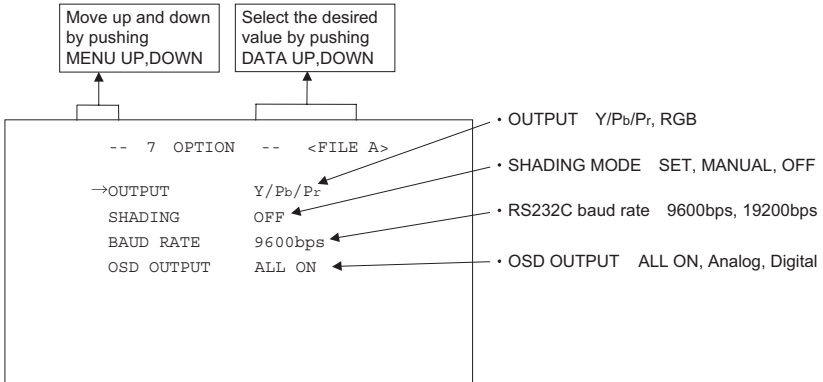

**(7. 1) Changing OUTPUT mode**

- ① Move the "→" to OUTPUT by pushing [MENU UP], [MENU DOWN] buttons.
- ② Select either Y/Pb/Pr or RGB by pushing [DATA UP], [DATA DOWN] buttons.

**(7. 2) Changing shading correction mode**

- ① Move the "→" to SHADING by pushing [MENU UP], [MENU DOWN] buttons.
- ② Select SET, MANUAL or OFF by pushing [DATA UP], [DATA DOWN] buttons.

**(7. 3) Changing manual shading correction mode**

- ① Move the "→" to MANUAL by pushing [MENU UP], [MENU DOWN] buttons.
- ② Select the desired value of manual shading correction by pushing [DATA UP], [DATA DOWN] buttons.

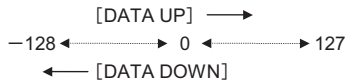

\* When the shading correction mode is set to anything other than MANUAL, the display turns off, so the setting cannot be made.

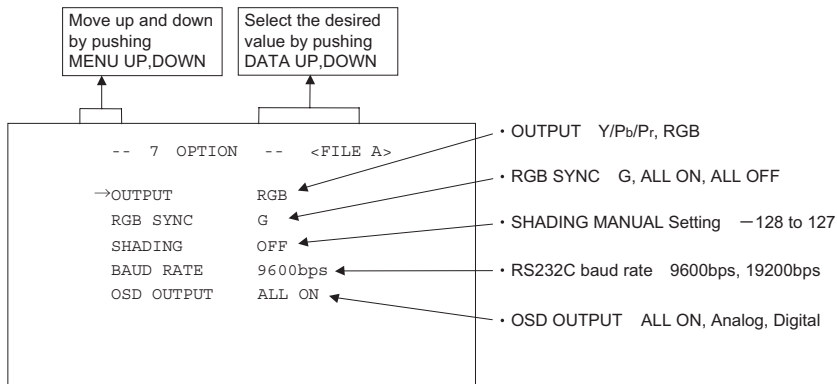

#### (7. 4) Changing RGB SYNC

① Move the "→" to RGB SYNC by pushing [MENU UP], [MENU DOWN] buttons.

② Select G, ALL ON or ALL OFF by pushing [DATA UP], [DATA DOWN] buttons.

\* When Y/Pb/Pr is selected at OUTPUT, RGB SYNC change cannot be performed.

#### (7. 5) Changing RS232C baud rate

① Move the "→" to BAUD RATE by pushing [MENU UP], [MENU DOWN] buttons.

② Select either 9600bps or 19200bps by pushing [DATA UP], [DATA DOWN] buttons.

#### (7. 6) Changing OSD OUTPUT mode

① Move the "→" to OSD OUTPUT by pushing [MENU UP], [MENU DOWN] buttons.

② Select either ALL ON, Analog, or Digital by pushing [DATA UP], [DATA DOWN] buttons.

\* ALL ON can be performed in the both analog and digital monitor.

If Analog is selected, it outputs only for analog.

If Digital is selected, it outputs only for digital.

Please select a mode depending on the type of the monitor display that is connected.

If incorrect mode is selected, the display might be disappear.

In that case, please refer to section "7.2 (8) Returning to factory settings". Please return other settings again.

#### (8) Returning to factory settings

The contents set of each scene file can be returned to the factory default status (preset status).

(1) Select a scene file to set to the factory default status by [FILE] button.

(2) If the color bar pattern or characters are displayed on the screen, press the [DISP] button to disable the color bar pattern and character display.

(3) Push [MENU DOWN] and [DATA DOWN] buttons simultaneously for approx. 1 second.

(4) The preset operation starts. When the preset operation finishes, the character PRESET OK is displayed for approx. 1 second.

### 7. 3 External Sync

When using the unit with an external sync signal to EXT. SYNC terminal on the rear panel.

When the external sync signal is input, the camera automatically switches its sync from the internal sync to the external sync.

| EXT. SYNC input | Operation               |
|-----------------|-------------------------|
| SYNC            | External sync with SYNC |

#### (1) External sync signal input conditions

SYNC (75Ω unbalanced) : 0.6 V (p-p) standard

#### (2) External sync frequency range

(59.94 Hz Setting) H : 33.716 kHz  $\pm$  35 ppm  
V : 59.94 Hz  $\pm$  35 ppm

(60 Hz Setting) H : 33.75 kHz  $\pm$  35 ppm  
V : 60 Hz  $\pm$  35 ppm

#### (3) Using the unit with external sync signal

Adjust H (Horizontal) phase if necessary to match the output of multiple cameras.

When adjusting H (Horizontal) phase, refer to the item "7.2 (6) SYNC".

##### **(3. 1) H (Horizontal) phase adjustment**

Observe the external sync signal and the video signal output waveform of the unit with a dual trace oscilloscope, and adjust H phase so that the H phases match.

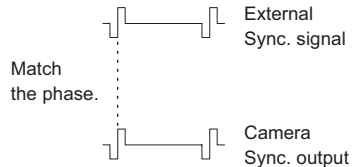

### 7. 4 Synchro. Scan Operation

The shutter speed can be set by the horizontal scanning period (1H).

#### (1) Setting by 1H

1/1125H to 560/1125H stands for the setting by the 1H and the shutter speed can be set by the 1H.

## 8. BEFORE MAKING SERVICE CALL

| <b>Symptom</b> | <b>Items to be checked</b>  |
|----------------|---|
| No picture     | <ul style="list-style-type: none"><li>· Is power supplied correctly?</li><li>· Is the power switch on, and the power LED illuminated?</li><li>· Is the lens iris adjusted correctly?</li><li>· Are the camera and video cables connected correctly?</li><li>· Is the shutter mode set correctly?</li><li>· Is the monitor on, and in working condition?</li></ul> |
| Poor color     | <ul style="list-style-type: none"><li>· Is the monitor adjusted correctly?</li><li>· Is the white balance of the camera adjusted correctly?<br/>(in modes other than automatic tracking)</li><li>· Is the matrix color correction set correctly?</li><li>· Is the illumination sufficient?</li></ul>  |
| Noise appears  | <ul style="list-style-type: none"><li>· Is the camera cable connected securely?</li></ul>   |

## 9. SPECIFICATIONS

\* These conditions are only satisfied when the camera control unit is connected to camera head model # IK-HD1H.

|                           |  |
|---------------------------|--|
| Power supply              | 12V DC $\pm$ 10%   |
| Power consumption         | Approx. 10.3 W (including a camera head)   |
| Pick-up system            | RGB, 3CCD, Micro prism system  |
| Image sensor              | 1/3 inch, IT—CCD   |
| Output pixels             | Horizontal : 1920, Vertical : 1080   |
| Scanning system           | 2 : 1 interlace  |
| Scan frequency            | [59.94 Hz setting] Horizontal : 33.716 kHz, Vertical : 59.94 Hz<br>[60 Hz setting] Horizontal : 33.75 kHz, Vertical : 60 Hz  |
| Sync system               | Internal/External (Automatic switching)  |
| Horizontal resolution     | 800TV lines standard   |
| Vertical resolution       | 800TV lines standard   |
| Sensitivity               | F6.8 standard (2000 lx, 3000 K)  |
| Minimum illumination      | 13 lx (F2.2, sensitivity + 18 dB)  |
| SN ratio                  | 56 dB standard (gain 0 dB, DNR OFF)  |
| Ambient temperature       | 0 °C to 40 °C (32° F to 104° F)  |
| Ambient humidity          | Less than 90%  |
| Weight                    | Approx. 730 g (1.61 lbs)   |
| External dimension        | 110(W) $\times$ 40(H) $\times$ 186(D) mm<br>(4.33"(W) $\times$ 1.57"(H) $\times$ 7.32"(D)) (excluding protrusions)   |
| Scene file(user memories) | 5 files (A, B, C, D, E)  |
| White balance             | ATW (Automatic tracing balance), AWB (Automatic white balance),<br>MANUAL (Manual)   |
| Gain                      | AUTO (Automatic gain control), MANUAL (Manual), OFF (0 dB)   |
| Output signal             | Y/P <sub>B</sub> /P <sub>R</sub> or RGB : 0.7 V (p-p) standard 75 $\Omega$ unbalanced, BNC connector<br>HD-SDI (SMPTE 292M) : 0.8 V (p-p) standard 75 $\Omega$ unbalanced, BNC connector   |
| External sync input       | HD SYNC 0.6 V (p-p) 75 $\Omega$ unbalanced BNC connector<br>[59.94 Hz setting] Horizontal : 33.716 kHz $\pm$ 35 ppm, Vertical : 59.94 Hz $\pm$ 35 ppm<br>[60 Hz setting] Horizontal : 33.75 kHz $\pm$ 35 ppm, Vertical : 60 Hz $\pm$ 35 ppm      |
| Sync signal output        | SYNC : 0.6 V $\pm$ 0.1 V 75 $\Omega$ unbalanced BNC connector<br>[59.94 Hz setting] Horizontal : 33.716 kHz $\pm$ 35 ppm, Vertical : 59.94 Hz $\pm$ 35 ppm<br>[60 Hz setting] Horizontal : 33.75 kHz $\pm$ 35 ppm, Vertical : 60 Hz $\pm$ 35 ppm |
| Interface                 | Serial data interface (RS-232C)  |
| Optional parts            | IK-HD1H (1/3 inch 3CCD camera head)<br>EXC—HD03 (Approx. 3 m (118") Camera cable)<br>EXC—HD06 (Approx. 6 m (236") Camera cable)<br>EXC—HD10 (Approx. 10 m (394") Camera cable)<br>EXC—HD30 (Approx. 30 m (1181") Camera cable)                   |

● Design and specifications are subject to change without notice.

# 10. EXTERNAL APPEARANCE DIAGRAM

Unit : mm [inch]

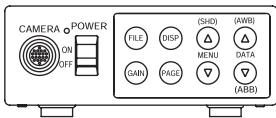
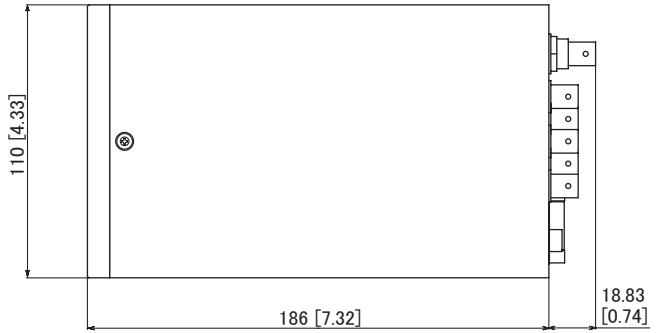

[Front]

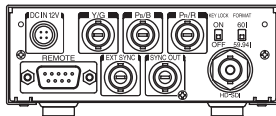

[Rear]

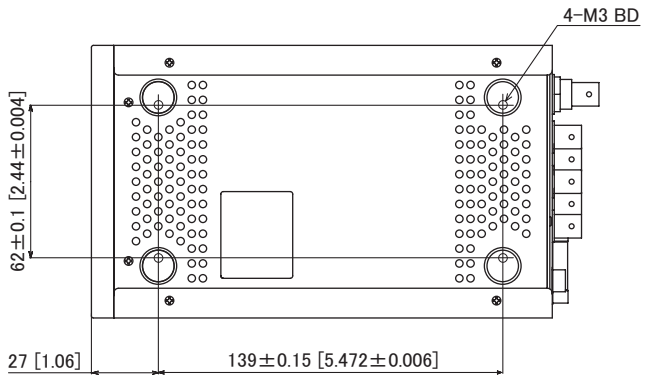

## Limited Warranty – TOSHIBA CCD Camera

The Imaging Systems Division of Toshiba America Information Systems, Inc. ("ISD") makes the following limited warranties with regard to this CCD Camera ("Product"). These limited warranties extend to the Original End-User ("You[r]").

### One (1) Year Limited Warranty of Labor and Parts

ISD warrants that this Product will perform in accordance with specifications for a period of one (1) year from the date of purchase by the Original End-User. During this one (1) year period, ISD will repair or replace the Product, if it does not perform as warranted. In order to take advantage of this Limited Warranty, You must: (a) deliver the Product to an ISD Authorized Service Provider ("ASP"); and (b) pay all transportation and insurance charges for shipment of the Product to the ASP. ISD reserves the right to substitute factory refurbished parts in place of those in need of repair.

### Instruction Manual (Owner's Manual):

You should read the Instruction Manual (Owner's Manual) thoroughly before operating this Product. Before seeking warranty service, you should check the troubleshooting guide in the Instruction Manual (Owner's Manual) and follow the instructions to correct the problem.

### Your Responsibilities

This Limited Warranty is subject to the following conditions:

1. You must provide the bill of sale or proof of purchase at the time that warranty service is required.
2. You must notify an ASP within thirty (30) days after You discover that the Product does not perform in accordance with specifications during the Limited Warranty period.
3. All warranty servicing of this product must be made by an ISD Authorized Service Provider.
4. You must pack the Product in its original carton using the original packing material, then insert the original carton containing the Product into another carton with additional packing material before shipping the Product to an ASP.

### DISCLAIMERS:

**ALL OTHER EXPRESS OR IMPLIED WARRANTIES ON THIS PRODUCT, INCLUDING THE IMPLIED WARRANTIES OF MERCHANTABILITY AND FITNESS FOR A PARTICULAR PURPOSE, ARE HEREBY DISCLAIMED. SOME STATES DO NOT ALLOW THE EXCLUSION OF IMPLIED WARRANTIES OR LIMITATIONS ON HOW LONG AN IMPLIED WARRANTY LASTS, SO THE ABOVE LIMITATIONS MAY NOT APPLY TO YOU.**

**IF THIS PRODUCT IS NOT IN GOOD WORKING ORDER AS WARRANTED ABOVE, YOUR SOLE AND EXCLUSIVE REMEDY SHALL BE THE REPAIR OR REPLACEMENT OF THE PRODUCT. IN NO EVENT WILL ISD OR ITS PARENT COMPANY OR ANY ASP BE LIABLE TO YOU OR ANY THIRD PARTY FOR ANY DAMAGES IN EXCESS OF THE PURCHASE PRICE OF THE PRODUCT. THIS LIMITATION APPLIES TO DAMAGES OF ANY KIND, INCLUDING ANY DIRECT OR INDIRECT DAMAGES, LOST PROFITS, LOST SAVINGS OR OTHER SPECIAL, INCIDENTAL, EXEMPLARY OR CONSEQUENTIAL DAMAGES, WHETHER FOR BREACH OF CONTRACT, TORT OR OTHERWISE, OR WHETHER ARISING OUT OF THE USE OF OR INABILITY TO USE SUCH PRODUCT, EVEN IF TAIS, ITS PARENT COMPANY, OR AN ASP HAS BEEN ADVISED OF THE POSSIBILITY OF SUCH DAMAGES OR OF ANY CLAIM BY ANY OTHER PARTY. SOME STATES DO NOT ALLOW THE EXCLUSION OR LIMITATION OF INCIDENTAL OR CONSEQUENTIAL DAMAGES FOR SOME PRODUCTS, SO THE ABOVE LIMITATIONS OR EXCLUSIONS MAY NOT APPLY TO YOU.**

**THIS WARRANTY GIVES YOU SPECIFIC LEGAL RIGHTS, AND YOU MAY ALSO HAVE OTHER RIGHTS WHICH MAY VARY FROM STATE TO STATE.**

**THIS LIMITED WARRANTY SHALL BE VOID IF THE PRODUCT OR PARTS HAVE BEEN SUBJECTED TO MISUSE, ABUSE, ACCIDENT, IMPROPER INSTALLATION, IMPROPER MAINTENANCE, OR USE IN VIOLATION OF ISD'S WRITTEN INSTRUCTIONS, OR WHERE THE PRODUCT HAS BEEN ALTERED OR MODIFIED WITHOUT ISD'S PRIOR AUTHORIZATION, OR UPON THE REMOVAL OR ALTERATION OF ISD'S FACTORY SERIAL NUMBER. LABOR SERVICE CHARGES FOR PRODUCT INSTALLATION, SET UP AND ADJUSTMENT OF CONTROLS ARE NOT COVERED BY THIS LIMITED WARRANTY.**

### How to Obtain Warranty Service – Step-By-Step Procedures:

To obtain warranty service, You should:

1. Contact an ASP for warranty service within thirty (30) days after the Product fails to comply with specifications.
2. Arrange for shipment of the Product to an ASP.
3. Securely pack the Product as described above, insure the carton, and include a letter explaining the problem and a copy of the bill of sale or proof of purchase.
4. Prepay all transportation and insurance costs.

Questions? If you have any questions, please check ISD's Web Site or send an e-mail as follows:

**Web Site:** <http://www.toshiba.com/taisisd/indmed>

**E-mail:** [CCTVtech.support@tais.toshiba.com](mailto:CCTVtech.support@tais.toshiba.com)

*No person, agent, distributor, dealer, authorized service provider, or company is authorized to change, modify, or extend the terms of this Limited Warranty in any manner whatsoever. The time within which an action must be commenced to enforce any obligation of ISD arising under this Limited Warranty or under any statute, or law of the United States or any state thereof, is hereby limited to one (1) year from the date You discover or should have discovered the problem. This limitation does not apply to implied warranties arising under state law. Some states do not permit limitation of the time within which You may bring an action beyond the limits provided by state law, so the above provision may not apply to You. This Limited Warranty gives You specific legal rights and You may also have other rights which vary from state to state.*

**TOSHIBA AMERICA INFORMATION SYSTEMS, INC.**

Imaging Systems Division  
9740 Irvine Boulevard, Irvine, CA 92618-1697

Copyright © 2007 Toshiba America, Inc. All rights reserved.

**TOSHIBA**